

Paloma



UNFLUED PORTABLE CONVECTION ROOM HEATER

To suit Paloma & Rheem Models:
PG-511FR
PG-711FR, PG-S711FR & PG-B711FR
RA-HNW711FR, RA-HNS711FR & RA-HNB711FR

Gas Types: Natural Gas (NG) or Propane (LPG)

CUSTOMER OPERATING AND INSTALLATION INSTRUCTIONS

Thank you for purchasing a Paloma/Rheem Convection Gas Space Heater



1. To operate this appliance safely and correctly, please read these instructions thoroughly.
2. This appliance must be installed in accordance with:
 - a. Local Gas Fitting Regulations
 - b. Municipal Building Codes
 - c. Australian Standard for Gas Appliance Installations AS5601-2002
 - d. Any other relevant Statutory Regulation
 - e. Manufacturer's installation instructions
3. This appliance must be installed, serviced and removed by an Authorised person.

Warranty Information

Please Record Below

Your Retailer:
 Address:
 Phone:
 Date of Purchase:

Note: There is no need to post this guarantee back, simply keep it in a safe place together with a copy of your purchase invoice.

Description	Domestic Applications		Commercial Applications	
	Parts	Labour	Parts	Labour
Combustion Chamber	10 Years Pro rata (*)	5 Years	1 Year	1 Year
All Other Parts	5 Years	5 Years	1 Year	1 Year

(*) Combustion chamber full replacement parts cost in the first five years, reducing 20% per year thereafter. Please note: The five-year domestic warranty is only applicable for units purchased after 1 March 2008.

Warranty Conditions:

- The warranty periods that are allocated for domestic use are based on heating requirements of a typical domestic dwelling. The warranty periods allocated under commercial use are for all other applications.
- Terms of this warranty are effective from date of purchase and the attending service technician reserves the right to verify this date by requesting a copy of the purchase invoice prior to commencement of any warranty work.
- These units must be installed correctly and the installation must conform to all regulations.
- These units must be serviced, installed, commissioned, repaired, and removed by an authorised person.
- No parts must be modified or removed from the unit.
- These units must be operated and maintained in accordance with manufacturer's operating instructions.
- This warranty applies only to the components supplied by the manufacturer. It does not apply to components supplied by others.
- Where a failed component is replaced under warranty, the balance of the original appliance warranty will remain effective. The replacement part or appliance does not carry a new warranty.
- We reserve the right to transfer functional components from defective appliances if they are suitable.
- We reserve the right to have the installed product returned to the factory for inspection and repair.
- Please note: general cleaning, maintenance, operation and wear & tear are not covered by the guarantee. Calls of this nature will be chargeable.

Warranty Exclusions:

The following exclusions may cause the warranty to become void and may result in a service charge and costs of parts (if required):

- Accidental damage and Acts of God.
- Failure due to abuse or misuse, improper maintenance, failure to maintain or improper storage.
- Failure due to incorrect or unauthorised installations.
- Failure or damage caused by alterations, service or repair work carried out by persons other than our authorised service technicians or agents.
- Where it is found that there is no fault with the appliance and the issue/s are related to the installation or is due to the failure of electric or gas supplies.
- We do not accept liability for any consequential damage or any incidental expenses resulting from any breach of the warranty OR claims for damage to a building or any other consequential loss either directly or indirectly due to fire or any other faults.

Product Overview

General Design Layout

<< FRONT VIEW >>

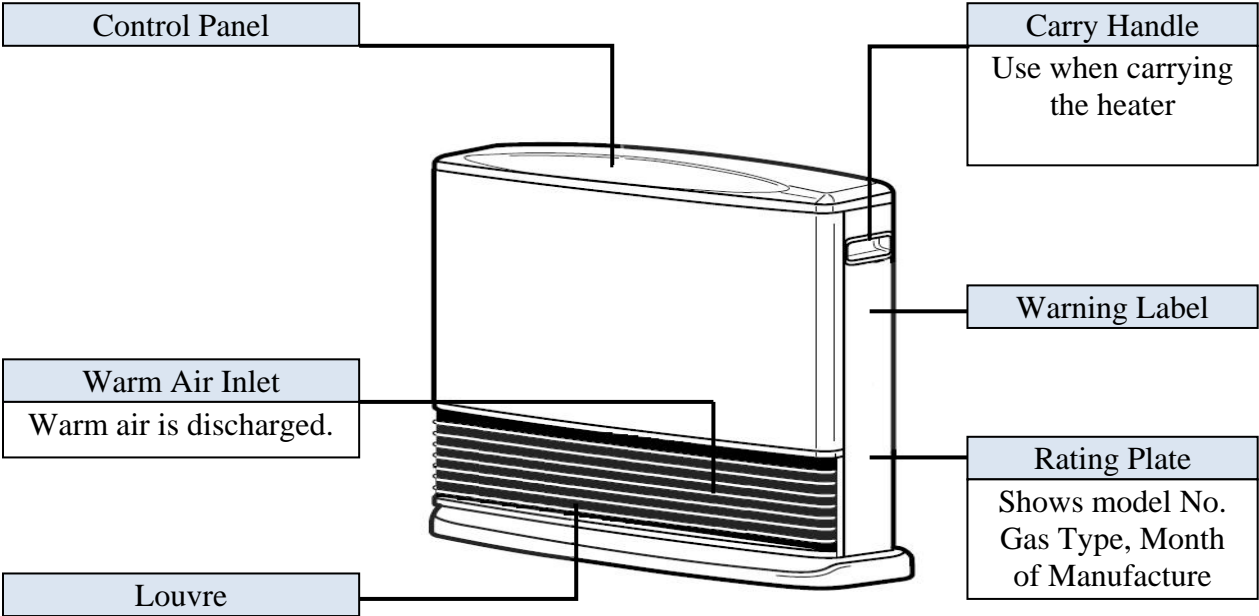

<< REAR VIEW >>

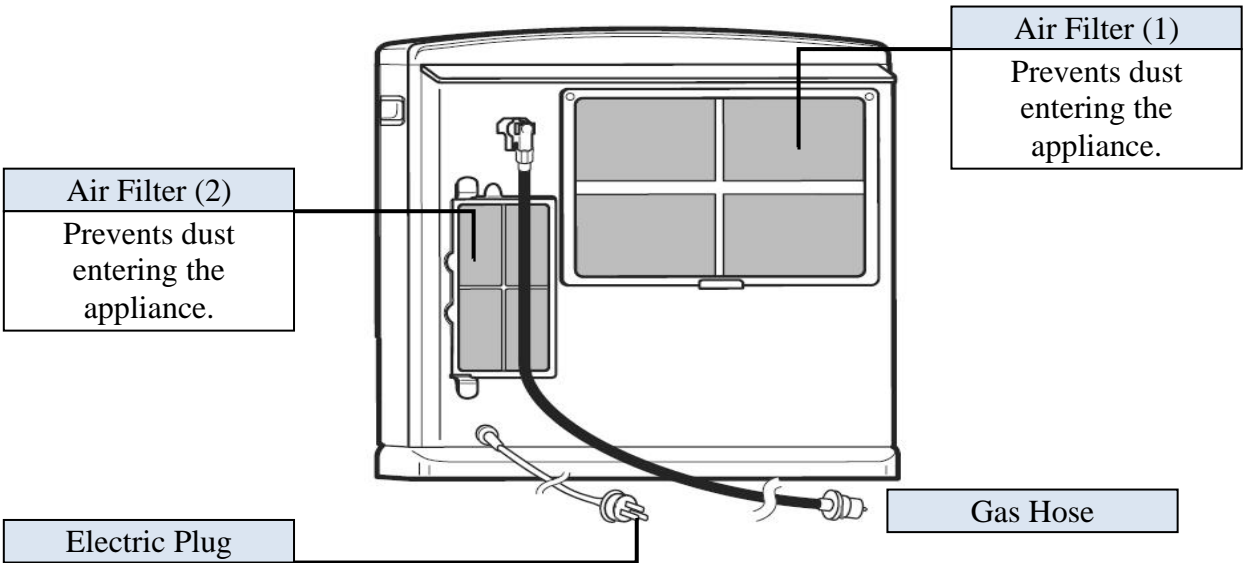

Control Panel

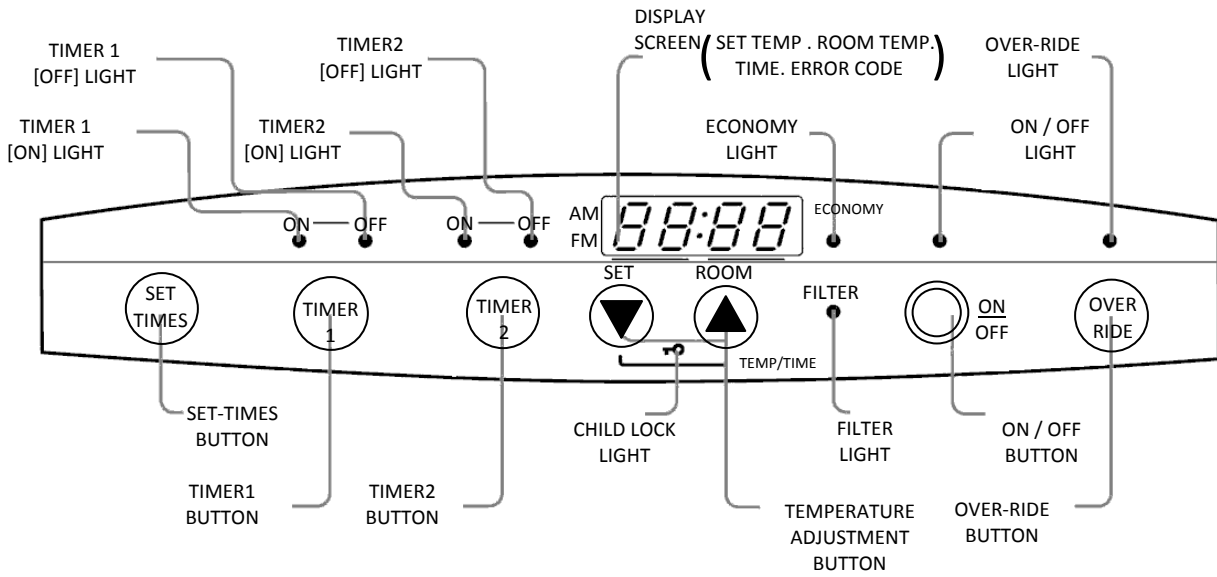

Remote Controller

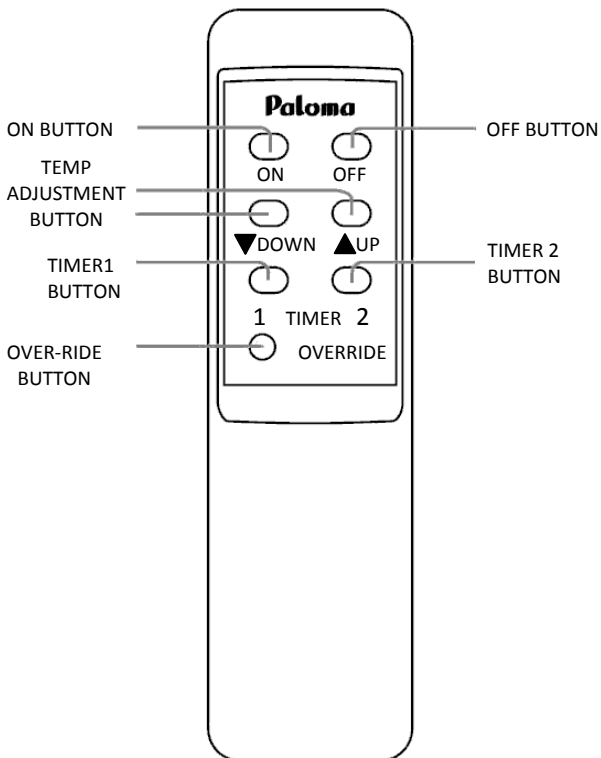

Battery replacement (AAA size 1.5V 2 pieces)

(1) Remove access panel.

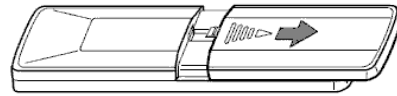

(2) Ensure that batteries are correctly fitted.

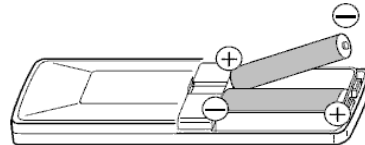

(3) Replace access panel and gently push into position.

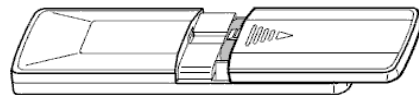

Features

- 5.9 Star Energy rating.
- One touch ON / OFF button.
- Electronic ignition.
- Adjustable room temperature - you can adjust the room temperature by pressing the up and down arrows on the control panel.
- Dual timers – the heater can be set to operate automatically at two separate periods of the day.
- Remote control operation – ON / OFF, temperature control (up/down), timer 1 & 2, override.
- Child lock function prevents accidental operation as well as children interfering with the controls.
- Automatic Economy function – when the room reaches the required temperature the heater automatically decreases room temperature by 1 deg C for every 30 minutes up to 2 deg C.
- Preheat function allows the heater to automatically operate one hour prior to the programmed starting time.
- Override function allows the user to manually override the preset program and operate the heater.
- NOX emissions - lower than the requirements of the Australian Standard.
- Energy efficient 7 stage modulating gas valve.
- Filter Clean Warning Device - When the air filter is clogged or hot-air outlet is blocked, the filter safety device will switch off the heater and the filter light will flash.
- Anti-tilt Safety Switch automatically shuts off gas flow if the heater is knocked or bumped.
- Oxygen Depletion Safety System automatically shuts off gas flow if the oxygen level in the room drops below a safe level.
- Flame Failure Device prevents flow of gas to burner if ignition fails or flame goes out.
- Power Failure Device prevents flow of gas to burner if there is a power failure.
- Overheat Safety Device – if the fan stops rotating for any reason the overheat switch shuts off the gas supply.
- Manufactured in Japan.

Specifications

MODEL	PG-711FR PG-S711FR PG-B711FR (NG only) RA-HNW711FR RA-HNS711FR RA-HNB711FR (NG only)	PG-511FR
Type	Convection Heater	Convection Heater
DIMENSIONS: (mm) (Approx: Height x Width x Depth)		
NG	494 x 531 x 226	494 x 531 x 226
LPG	494 x 531 x 237	494 x 531 x 237
GAS INPUT - NG	NG	NG
High (MJ/h)	25	18.5
Low (MJ/h)	6.2	6.7
GAS INPUT - LPG	LPG	LPG
High (MJ/h)	23	18.5
Low (MJ/h)	6.2	6.7
Output (kW)	6.1	4.7
HOSE Connections (mm)	Φ 9.5	Φ 9.5
STAR ENERGY RATING	5.9	5.9
MINIMUM ROOM SIZING (Cu.M)	62	45
COLOUR	Off White, Silver & Charcoal	Off White
NET WEIGHT		
NG (KGS)	11.7	11.7
LPG (KGS)	12.7	12.7

EXTERNAL DIMENSIONS FOR NATURAL GAS UNIT (mm)

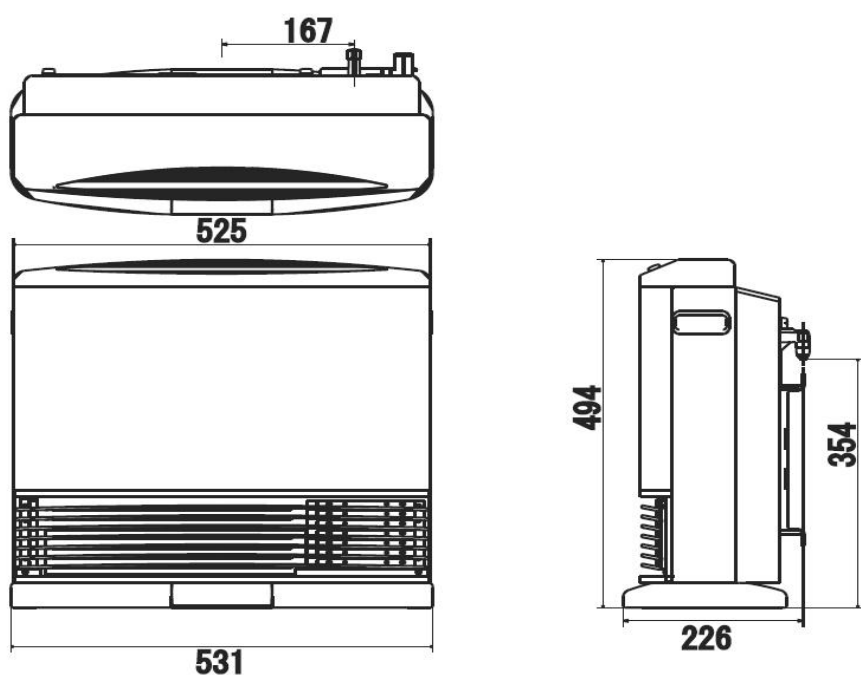

Preparation

- (1) Remove heater from carton.
- (2) Please ensure that the gas specified on the rating plate matches your gas supply. Using a different type of gas may cause an explosive ignition resulting in injury, damage to heater or malfunction of the oxygen depletion safety system. Do not install heater if it is the wrong gas type. Please contact your place of purchase immediately.
- (3) Check room sizing – refer specifications. Do not install if the actual room size is less than the specified minimum room size requirements.
- (4) A dedicated 240V Earthed 10 Amp power point must be used with this heater.

Notice to Victorian Customers: This appliance must be installed by a licensed person as required by the Victorian Building Act 1993. Only a licensed person will give you a compliance certificate showing that the work complies with all relevant standards. Only a licensed person will have insurance protecting their workmanship for 6 years. Make sure you use a licensed person to install this heater and ask for a compliance certificate. – Message from the Victorian Plumbing Commission.

Safety Instructions

To ensure safe and proper use of this heater, please read these instructions carefully.

Danger – Indicates an immensely hazardous situation which, if not avoided, will result in serious injury or death in the most extreme situations.

Warning – Indicates a potentially hazardous situation which, if not avoided, could result in serious injury or death in the most extreme situations.

Caution – indicates a potentially hazardous situation which, if not avoided, may result in minor injury.

Danger

If a gas leak is detected:

- Do not turn power switches on or off.
- Do not plug or unplug electrical appliances.
- Do not use the telephone.

Flame or sparks may ignite the gas and cause a fire:

- Cease operation immediately and close the gas valve.
- Open windows and doors for ventilation.
- Contact your gas supplier, a licensed plumber or Rheem Service on 131 031.

Warnings

- For information on the gas consumption and gas type please see data plate.
- Please ensure that the gas specified on the rating plate matches your gas supply. Using a different type of gas may cause an explosive ignition resulting in injury, damage to heater or malfunction of the oxygen depletion safety system. Do not install heater if it is the wrong gas type. Please contact your place of purchase immediately.
- Electrical supply must be 240v, 50 Hz.
- Use only the gas hose supplied with the heater to avoid risk of gas leakage.
- Ventilation and room sizing must comply with local regulations. This heater is not intended for a fireplace insert.
- Ensure your room is correctly ventilated while unit is operating. Continuous use decreases the oxygen level in the room which activates the oxygen depletion safety system.
- Do not allow curtains or other flammable materials or aerosol cans to come into contact with the heater. It may cause a fire or the pressure in the aerosol-can may increase resulting in an explosion.
- Do not use or store gasoline, benzene, aerosol or any other flammable material near this appliance. It may result in a fire.
- Do not post or allow children to post articles such as paper, cloth or any other foreign material into the louvres or air inlet of the heater. Do not block the louvres or the air inlet of the heater. This may cause a fire or overheat the appliance.
- Do not leave the heater unattended or alight when you leave the house.
- Do not sit, stand or sleep directly in front of the heater. Receiving direct heat continuously may cause low temperature burns. The aged, children, a very tired person, a person with sensitive skin or an intoxicated person must be supervised at all times.
- If your heater fails to operate correctly or you detect any unusual odours during its operation, cease operation immediately and close the gas valve. Refer to the trouble shooting section of these instructions and if the problem cannot be fixed please contact your gas supplier or Rheem service.
- This heater must be repaired or serviced by an authorised person. Repairs carried out by an unauthorised person may cause abnormal operation. The heater must be serviced at least once every three (3) years.
- Do not place articles on or against or in front of warm air outlet or air filter of this appliance.
- Do not spray aerosols in the vicinity of this appliance whilst it is in operation.
- Do not use this heater in areas where spray painting is taking place or in areas such as hairdressers where there may be lots of fluff and dust or where aerosols may be used.
- All replacement parts must be approved Paloma spare parts.
- This heater may circulate large volumes of air. If the air in the room contains any cigarette smoke or cooking vapours, it may affect the appearance of carpets, furniture and drapes, etc.
- Clean the air filter regularly (at least once a week).

Caution

- Do not move the heater during operation.
- Do not use for any other purpose other than for heating. Must only be used as a space heater.
- Do not touch the warm air outlet during operation. Supervise young children or infirm persons near the heater. Also ensure that children do not play with this appliance.
- Do not sit, stand or lean on the heater.
- Do not insert your fingers into the louvres or the air inlet of the heater.
- Do not cut the electrical cord to extend the lead. Install the heater where the original electrical cord reaches a wall socket.
- Do not unplug or shut down during operation. This may cause overheating.
- Do not place the heater near an opening door. The heater could be knocked over.
- Do not touch the electric plug with wet hands as this could cause an electric shock.
- Do not pull the electrical cord to unplug as this could break the cord and start a fire.
- Place a flat board for stability when placing the heater on soft or thick carpet. Placing directly on to a carpet may discolour the carpet.
- Ensure that recommended clearances are maintained at all times.
- This heater is designed for domestic household applications only. Using this heater in commercial applications will shorten its life significantly.
- In case of thunderstorms, cease operation and unplug the electrical cord.
- Do not use sprays containing silicon in the vicinity of the heater. It damages the oxygen depletion safety device.
- Do not install in a place where the heater may be affected by wind. The flame could be blown out by a strong wind.
- If the heater is shut off by the oxygen depletion safety system, please ensure you ventilate the room immediately for satisfactory combustion.

Installation

- This heater must be installed with a minimum clearance of 50mm from the rear and sides. These clearances must be maintained at all times.
- There must be a minimum clearance of 750mm from the hot air outlet.

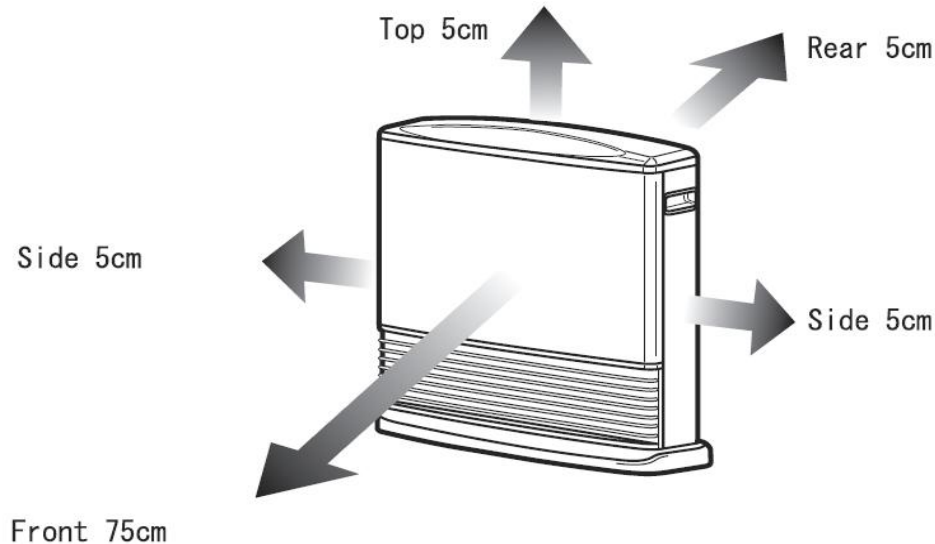

- Do not install in a room with inadequate ventilation – refer to Australian Standard AS5601.
- Do not install on an uneven surface or a vibrating floor.
- Do not install directly on to carpet or timber floor or vinyl floor or cork floors. Heat emanating from these appliances may discolour the carpet or damage your floor. It is recommended that a mat or flat board be placed in front of this appliance extending at least 800mm in front of it.
- Do not install near a door or windy location or under shelves or in a confined space. E.G; fireplace.
- Do not install in a bedroom or bathroom or combined living/sleeping areas or toilets or sauna.
- Do not install where flammable materials are likely to come into contact with the heater.
- Do not install where water may splash or near another heat source.
- Do not install in a caravan, mobile home or recreational vehicle.
- Do not connect to a Propane (LPG) gas cylinder indoors.
- This appliance is not designed to be built into walls or cupboards.
- If you move house check the gas type in the house where you are moving to.
- The bayonet plug on the factory fitted flexible hose simply plugs into your bayonet fitting.
- Do not place heater against wall or on a shelf.
- Always place heater on flat surface and away from strong draughts.
- It is recommended that a dedicated 240V 10Amp power point be used with this appliance. Do not use power boards or double adaptors to operate this appliance. Heater must not be located below a power socket – outlet.
- Turn the heater off after use. Do not unplug the heater while it is in operation or while the fans are still cycling.
- Do not move the heater while it is in operation.
- When the heater is operated for the first time or after long periods of non use a slight odour may be emitted, this is normal. However if odours persist switch off the heater and contact Rheem Service.

Operating Instructions

【Control Panel】

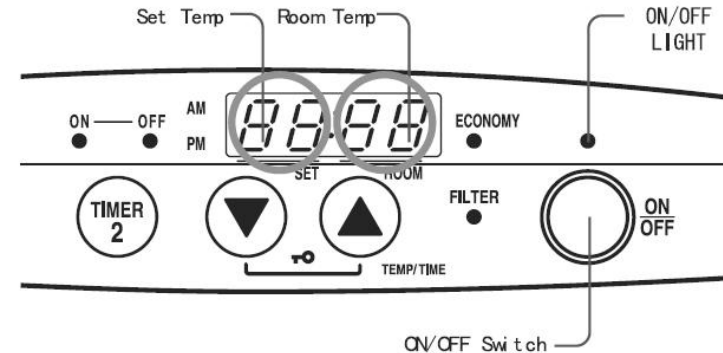

【Remote Control】

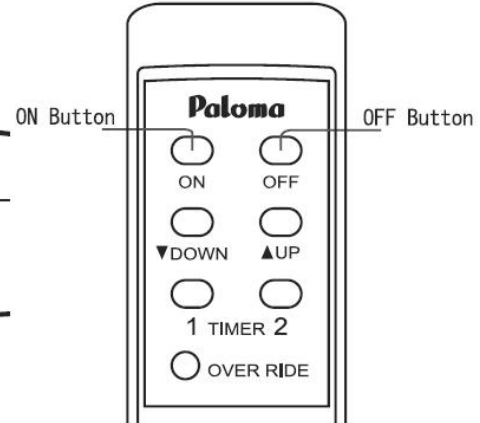

Before you begin ensure that the gas hose connector and electrical cord are plugged in correctly.

START UP

- Press the ON / OFF Button once to start the heater and the operation light (green) will light up.
- After a short delay the combustion light (red) will light up, this indicates proper ignition has been achieved and the burner is on.
- Set temperature and room temperature are displayed on the screen.
- When the ON / OFF light is glowing green the heater can be switched on by pressing the Remote Control button.

TURNING HEATER OFF

- Press ON / OFF button. The ON light goes out. Then press the OFF button on Remote Controller.
- After the heater is turned off the convection fan will continue to operate for up to 4 minutes. This is to lower the temperatures inside the heater and is normal.
- Please do not unplug the heater while the fan is still operating.

Important Information:

- When using the heater for the first time or after long periods of disuse, ignition may not occur the first time it is operated as there may be air within the pipes.
- The unit may make noises after igniting or extinguishing the heater. This is due to expansion and contraction of the heater components and is normal.
- If the heater fails to light, repeat the procedure after first pressing the ON / OFF button to turn the unit off.
- Do not start then stop immediately. This may cause the heater to overheat or the filter light to come on.
- The economy operation will not function if the set temperature reaches a temperature in excess of the room temperature.
- For safety reasons the heater will automatically stop after 8 hours of continuous operation except when the timers are used.

AUTOMATIC ECONOMY OPERATION

- The economy operation allows the heater to heat the room to the set temperature and after a period of 30 minutes it allows the temperature to automatically reduce by one degree. After another 30 minutes the temperature is reduced by a further one degree to a maximum of two degrees.
- This subtle reduction in temperature is not noticed by the user.

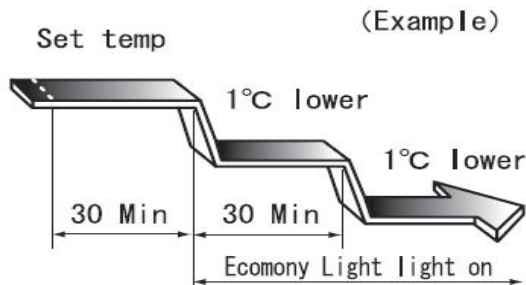

ROOM TEMPERATURE ADJUSTMENT

- When the heater is operational the display screen will show the [SET] temperature and The [ROOM] temperature:
- [SET] indicates your desired temperature and [ROOM] indicates current room temperature.
- You can pre-set the [SET] temperature by raising or lowering the temperature selection buttons. For Eg; Select 22 Degrees C as your desired temperature and this temperature is then memorised into the control system.
- [SET] temperature selection can range from 16 Degrees C (low) – 26 Degrees C (high).
- [ROOM] temperature is indicated as follows:
 - {L} – lower than 0 Degrees C
 - {1} – {30} Degrees C
 - {H} – Higher than 31 Degrees C

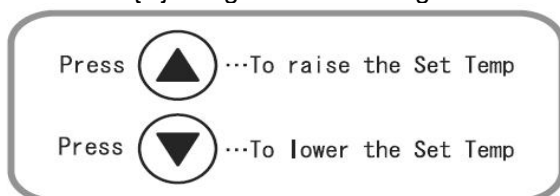

Important Information:

- Please assume the Room temperature is not an exact temperature.
- Your room may not arrive at the [SET] temperature or may exceed the [SET] due to the size of room, construction of room, location of the heater or external temperature. If this occurs please switch heater OFF and then ON again. In the case of immediate re-operation the [ROOM] temperature shown on the display screen may be higher than the actual [ROOM] temperature for at least 3 to 4 minutes.
- Please note for the heater to ignite the [SET] temperature must be higher than the [ROOM] temperature.

OVER-RIDE FUNCTION

The OVER-RIDE function allows the user to manually over-ride the preset program to operate the heater.



[Press OVER-RIDE button]

Over-ride operation is switched ON:

- The OVER-RIDE light glows
- After combustion the ON / OFF light glows red.
- Set temperature and Room temperature will appear on the screen.

Over-ride operation is switched OFF:

Over-ride light glows.

ON / OFF light glows green and timers are ready.

After the heater turns off the convection fan will continue to operate for up to 4 minutes. Do not unplug while fan is operational.

Between Timer Operation

Press {OVER-RIDE} button ON ...The heater operates while the timers are on hold.

Press {OVER-RIDE} button OFF...The heater turns off and the preset program will resume.

During Timer Operation

Press {OVER-RIDE} button ON ...Stops operation.

Press {OVER-RIDE} button OFF...The heater will operate again.

SETTING THE CLOCK

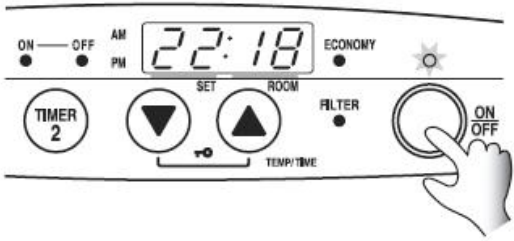
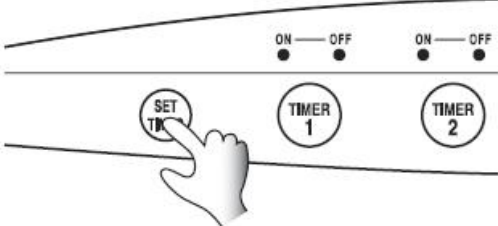
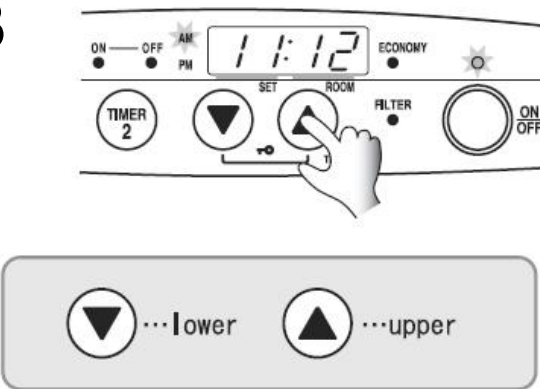
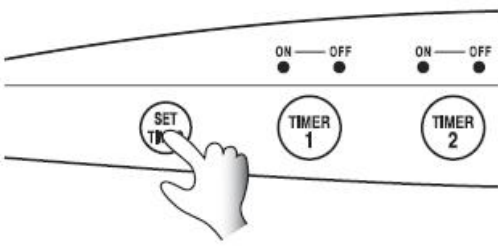
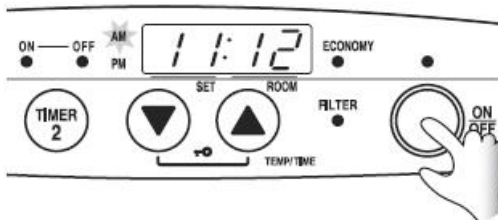
<p>1</p> 	<p>Press ON / OFF button.</p> <ul style="list-style-type: none"> • ON / OFF Light glows • The Set temp and Room temp are displayed on the screen.
<p>2</p> 	<p>Press SET TIMES button</p> <ul style="list-style-type: none"> • Time is displayed.
<p>3</p> 	<p>Adjust the time</p> <ul style="list-style-type: none"> • To adjust the time of day press the ▼ down or ▲ up button until the correct time is reached. <p>[Example] To set clock for 11:12am</p> <ol style="list-style-type: none"> (1) Adjust the hour. Keep pressing the adjustment button until 11.00am is displayed. (2) Adjust the minute. Press the adjustment button again until 11:12am is displayed.
<p>4</p> 	<p>Press SET TIMES five times.</p> <ul style="list-style-type: none"> • The screen goes back to Set temperature and Room temperature mode.
<p>5</p> 	<p>Press ON / OFF button to exit clock setting mode.</p> <ul style="list-style-type: none"> • ON / OFF Light goes out. • Clock will be shown on the screen.

Important Information:

If the heater is unplugged or if there is a power failure please reset the clock.

PROGRAMMING THE ON / OFF TIMER(S)

Two timers are available – Timer 1 and Timer 2.

You are able to set the start time and shutdown time for TIMER 1 and TIMER 2.

PROGRAMMING THE TIMER

Before programming the Timers, please ensure that the correct time is set.

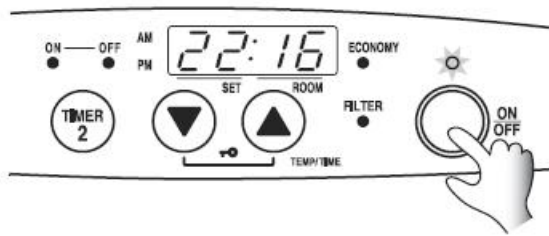
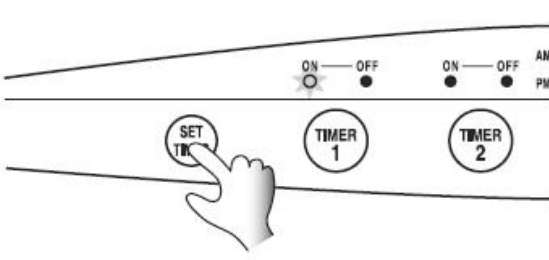
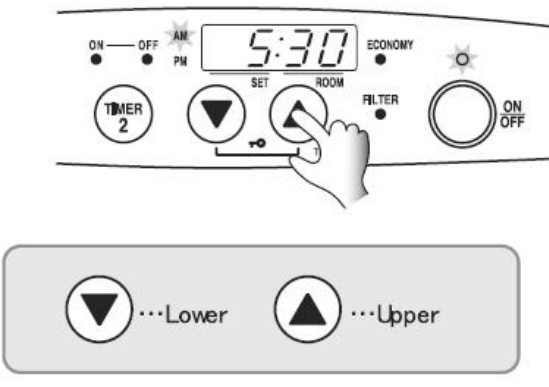
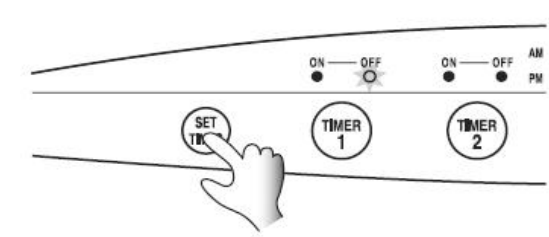
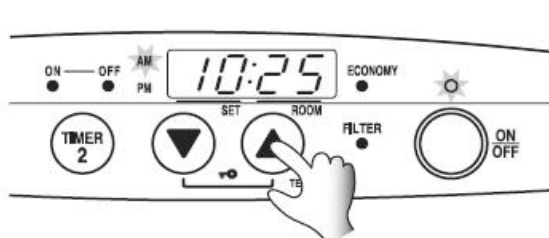
<p>1</p> 	<p>Press ON / OFF button</p> <ul style="list-style-type: none"> • ON / OFF Light glows. • The Set temp and Room temp are displayed on the screen.
<p>2</p> 	<p>Press SET TIMES button twice.</p> <ul style="list-style-type: none"> • The TIMER 1 “ON” light flashes. • The TIMER 1 time is displayed on the screen.
<p>3</p> 	<p>Adjust TIMER 1 “ON” or start up time as required.</p> <ul style="list-style-type: none"> • To set the Timer 1 “ON” time press the ▼ down or ▲ up button until the correct time is reached. <p>[Example] To set the TIMER 1 “ON” time to 5:30AM.</p> <ol style="list-style-type: none"> (1) Adjust the hour (2) Keep pressing the adjustment button until 5:00AM is displayed. (3) Adjust the minute. (4) Press the adjustment button until 5:30AM is displayed.
<p>4</p> 	<p>Press SET TIMES button.</p> <ul style="list-style-type: none"> • TIMER 1 “OFF” light flashes. • TIMER 1 “OFF” time is displayed on the screen.
<p>5</p> 	<p>Adjust TIMER 1 “OFF” or shut off time as required.</p> <ul style="list-style-type: none"> • To set the TIMER 1 “OFF” time press the ▼ down or ▲ up button until the correct time is reached.

6

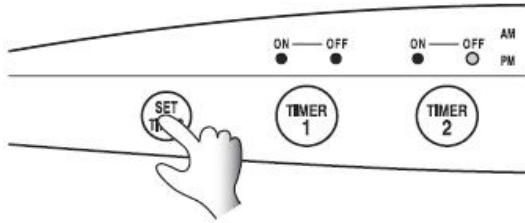

Press SET TIMES button to Set TIMER 2

- TIMER 2 "ON" light flashes.
- TIMER 2 "ON" time is displayed on the screen.

7

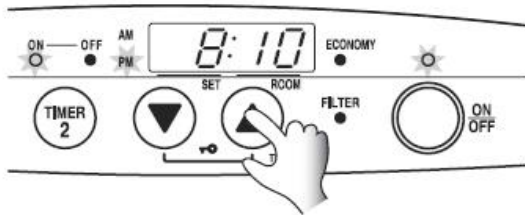

Adjust TIMER 2 "ON" time as required

- To set the TIMER 2 "ON" time press the ▼ down or ▲ up button until the correct time is reached.

8

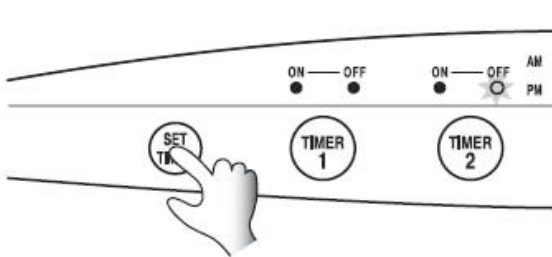

Press SET TIMES button

- TIMER 2 "OFF" light flashes.
- TIMER 2 "OFF" time is displayed on the screen.

9

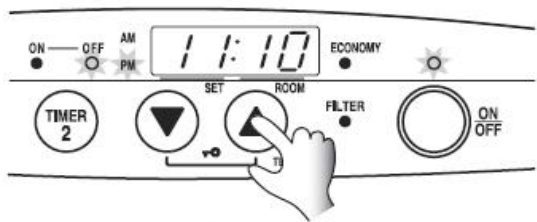

Adjust TIMER 2 "OFF" time as required

- To set the TIMER 2 "OFF" time press the ▼ down or ▲ up button until the correct time is reached.

10

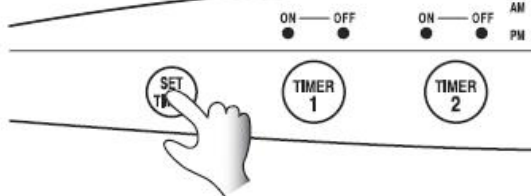

Press SET TIMES button to exit SET TIMES mode.

- The screen goes back to SET temperature and ROOM temperature mode.

11

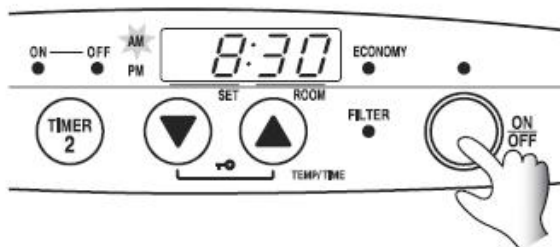

Press ON / OFF button to turn off

- ON / OFF lamp lights
- The current time will be shown on the screen.

Caution

The operation and shut down times for the timers are stored in memory. If the requested operation and shut down times for the timers are the same it is not necessary to set up anew.

12

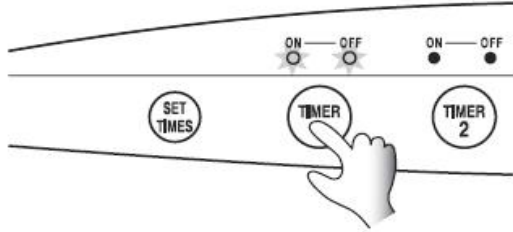

Press the TIMER/S button/s.

- You can select TIMER 1 or TIMER 2 or both by pressing the TIMER 1 and/or TIMER 2 buttons.
- Selected TIMER's [ON] [OFF] lights will glow.
- The TIMER operation is not set and will not function if the TIMER's "ON" and "OFF" lights are not glowing.
- If during operation combustion shuts down then the ON / OFF light will glow green.

13

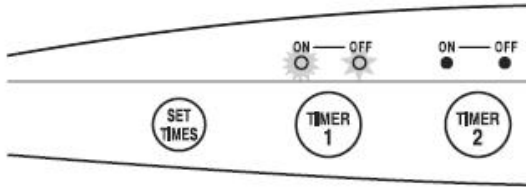

- Selected TIMER 1 [ON/OFF] light flashes.
- ON / OFF light turns from green to red.
- Repeat operation for TIMER 2

Operation of timers

This section provides timer operation via the unit, but it is possible to control the timers by using the remote control.

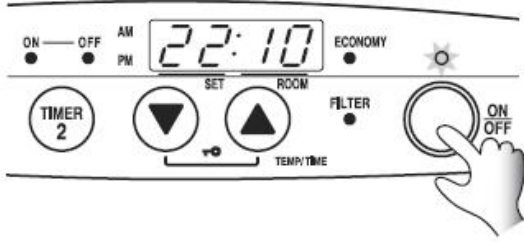
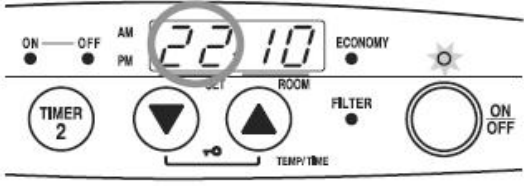
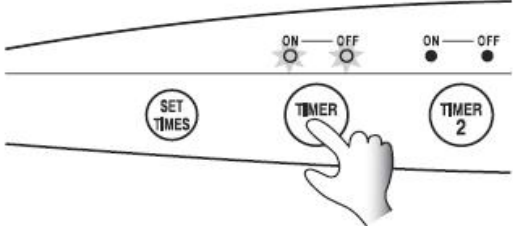
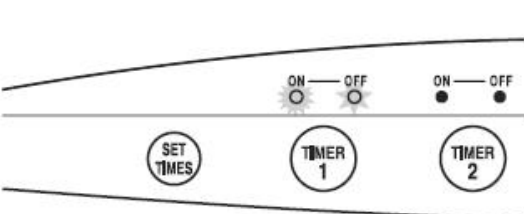
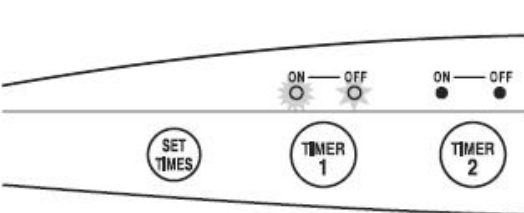
<p>1</p> 	<p>Please ensure that the main power is ON</p> <ul style="list-style-type: none"> • While main power is ON. ON / OFF light glows green or glows red after ignition. • Please ensure the TIMER's are programmed as per previous section.
<p>2</p> 	<p>Please ensure you take the following steps.</p> <ul style="list-style-type: none"> • Is the gas valve fully opened? • Set temperature is adjusted to desired temperature? • There are no objects in front of the louvre to block the air outlet.
<p>3</p> 	<p>Press the TIMER/S button/s.</p> <ul style="list-style-type: none"> • You can select TIMER 1 or TIMER 2 or both by pressing the TIMER 1 and/or TIMER 2 buttons. • Selected TIMER's [ON] [OFF] lights will glow. • The TIMER operation is not set and will not function if the TIMER's "ON" and "OFF" lights are not glowing. • If during operation combustion shuts down then the ON / OFF light will glow green.
<p>4</p> 	<p>Pre-heat function: [At one hour prior to the set time the heater will operate automatically – Example; If the ON time is set for 5.30AM then the heater will automatically start up at 4.30AM]</p> <ul style="list-style-type: none"> • Selected TIMER 1 or TIMER 2 [ON] light flashes. • ON / OFF light turns from green to red.
<p>5</p> 	<p>[Timer operation start time]</p> <ul style="list-style-type: none"> • Selected TIMER's [ON] [OFF] light flash.

6

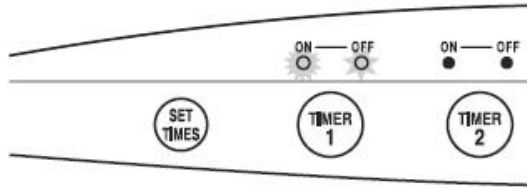

[Timer Operation shut down time]

- Selected TIMER's [ON] [OFF] light glows.
- Combustion shut down and the heater stands by for timer operation.
- ON / OFF light glows green.

cancelling the timers:

- Press ON / OFF button or OFF switch on remote control or Press the TIMER button.
- To manually cancel the TIMER's press the TIMER buttons and lights will turn off.
- If the Child Lock function is activated, unlock and press the TIMER buttons to cancel the programmed timers.

Important Information:

- For safety reasons the heater will operate at 26°C automatically if the Set temperature for the TIMER function is adjusted [H].
- If the electric cord is unplugged or in case of power failure, the timers will be cancelled so the selected timers will not operate. Please program the TIMER's once again.
- You cannot overlap set times between the two timers. If the timers are overlapped the time that is set first will have priority and the timer set second will be cancelled.
- The timer settings will continue to operate if they are not cancelled.

PRE-HEAT FUNCTION

This heater has a pre-heat function which operates the heater one hour prior to the programmed starting time of the timer. This function will warm the room before the programmed starting time of the timer. This is an automatic function and cannot be cancelled.

CHILD LOCK

This heater has a child-lock function which prevents accidental operation as well as children interfering with the controls.

Lock function is activated via the operational panel.

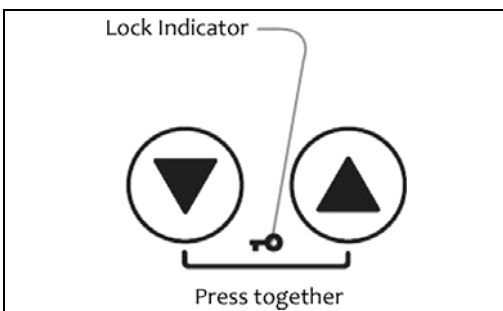

Press adjustment buttons together for one second.

- Lock indicator glows.

cancelling the lock

Press adjustment buttons together again.

- Lock indicator turns off.

Important Information:

If the heater is locked during operation it is only possible to press the ON / OFF button.

If child lock is activated when the heater is not operating no button on the control panel can be activated.

Trouble Shooting

Please check following important points before calling for a service technician:

CONDITION	SUGGESTED REMEDY
The heater does not operate (ON/OFF - operation light does not glow green)	Check that the power cord is plugged in and the power turned on
	Circuit breaker or fuse is blown
	Child lock is set
	Check that gas is turned on
	See that enough gas is left in LPG tank (in case of LPG appliance)
Does not ignite (ON/OFF - operation light does not glow red)	Supply gas valve is not fully opened
	Air in gas hose
Heater turns off during operation	Air filter is clogged and filter lamp flashes. Please clean air filter.
	Check that hot air outlet is not blocked
Room does not become warm enough.	Set-temperature is set too low
	Window or door is opened
	Supply gas valve is not fully opened
	Room size does not suit the heater capacity
	Obstruction within 75cm in front of heater
Flame is extinguished during operation	Check that the room is well ventilated (Amount of oxygen inside the room may be insufficient)
Gas smell	The hose is not securely connected
	The hose is damaged
	Turn off heater and call a licensed plumber
Heater smells during use	The heater will give out a strong odour if the room has been recently painted or the floors have been waxed or polished. Ventilate room properly before use
Heater smells or smokes when using first time	The smell or smoke comes from oil used during manufacture. Operate the heater for a while in ventilated room.
The fan keeps operating after the heater is switched off	It stops after the temperature inside the heater has cooled. No action required.
The heater creaks at the time of lighting or switching off	The sound is caused by expansion and contraction of metallic parts when the product is heated or cooled. No action required.
The heater does not ignite when using first time in the season, when not used for a long time or when the hose is re-connected.	There is air in the gas hose
	Repeat ignition procedure until the heater ignites (the lamp glows red to purge the air in the hose)
Noisy during ignition or shutdown.	This is a normal operation noise.
The heater makes hissing noise.	This is a normal gas flow noise.
Does not ignite immediately after shutdown.	Please wait until the heater cools down. The heater will re-ignite automatically 20 seconds later.
Does not operate after is accidently unplugged.	Please wait until the heater cools down. Try to restart after a few minutes.

Error Codes

These heaters are fitted with self diagnostics electronics. Should a fault occur the heater will shut down and the fault with a pair of digits will be displayed in the display screen. Refer to the following table for probable cause and suggested remedy.

Error code	Problem	Probable Cause	Suggested Remedy
11	Ignition Failure	Air filter is clogged	Clean Air Filter and operate again. If problem persists call for service.
		Gas valve is not fully opened	Check gas valve is fully open and operate again. If problem persists call for service.
		The gas supply volume is inadequate	Call for a licensed plumber.
12	Flame Failure	Air filter is clogged	Clean Air Filter and operate again. If problem persists call for service.
		Gas valve is not fully opened	Check gas valve is fully open and operate again. If problem persists call for service.
		Insufficient ventilation	Open windows slightly or install ventilation points and operate again. If problem persists call for service.
		The gas supply volume is inadequate	Call for a licensed plumber.
14	Thermo Switch Cut Off	Thermo switch is off	Call for service.
		Air Filter is clogged	Clean Air Filter and operate again. If problem persists call for service.
		Louvre is obstructed	Remove obstruction and operate again. If problem persists call for service.
16	Room Temperature Too High	Room temperature thermistor failure	Call for service.
31	Room Temperature Thermistor is Abnormal	Room temperature thermistor failure	Call for service.
33	Overheat Thermistor is Abnormal	Overheat Thermistor failure	Call for service.
62	Abnormal Fan Speed	Fan failure	Call for service.
71	Gas Valve is Abnormal	Gas valve failure	Call for service
72	Thermocouple Circuit is Abnormal	Thermocouple failure	Call for service
73	Gas Circuit is Abnormal	Gas circuit failure	Call for service.
76	Communication Error	Tilt over switch is activated	Place heater on a stable and level surface and operate again. If problem persist call for service.
		Wiring is disconnected	Call for service.

Inspection and Maintenance

Disconnect gas hose and turn heater off. Unplug and wait until the heater cools down.

- Be sure to carry out daily inspection and maintenance.
- Do not use the heater if you believe something is wrong.
- It is recommended that your heater be serviced periodically.

Points to check

1. There are no flammable materials in the vicinity of the heater.
2. Air filter is fitting correctly and is not dirty.
3. The hose is correctly connected without kinking or twisting.
4. There is no damage to the electric cord.

Maintenance



Caution

Wear gloves

- Be careful of sharp edges.

Warning

Do not use cleaning cloth, thinner, benzene, acid or alkaline detergent.
This will avoid discoloration of the paint and plastic components.

Maintenance of Heater Outer Jacket

(Preferable to clean once a month)

Keep the heater clean

- Use damp soft cloth to wipe.
- Use mild soapy water for severe dirt.

MAINTENANCE OF THE LOUVRE

Use vacuum cleaner to remove dirt from the louvre.

Make sure that the fan is not working before cleaning.
White powder may form on the louvre. Wipe off with soft cloth.

⚠ Caution

Do not press the louvre heavily. Do not apply strong pressure to the Louvre.

- The louvre may break causing discolouration of the floor or carpet due to the change in heat discharge.

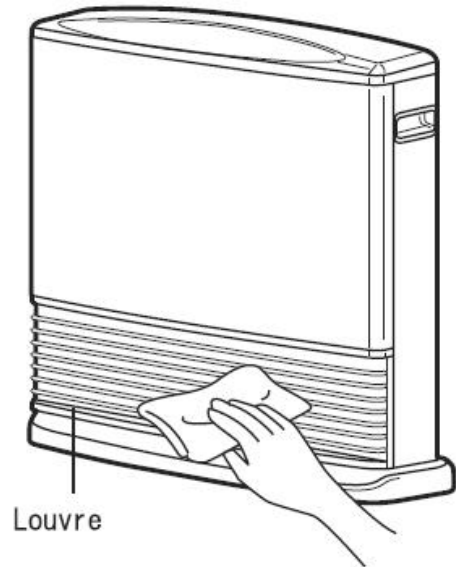

MAINTENANCE OF THE AIR FILTER

- If the Air Filter lamp flashes, clean Air Filters (1) and (2)
- Use vacuum cleaner to remove dirt on the Air Filters.
- Air Filter (1) could be taken off to clean. Use mild soapy water for severe dirt and refit after drying. If Air Filter is wet, the heater may not operate correctly.
- Do not remove Air Filter (2)

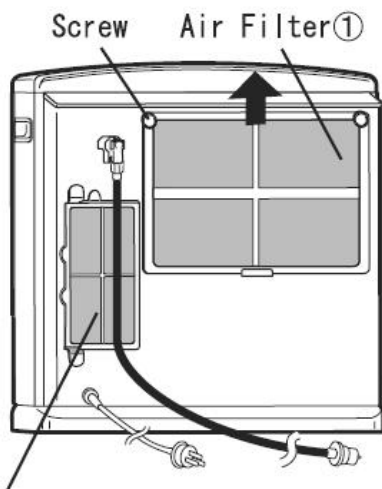

REMOVE THE FILTER

1. Remove the screw.
2. Hold the upper side of Air Filter (1) and pull upward. (Do not hold and pull strongly. It may cause the air filter to break).

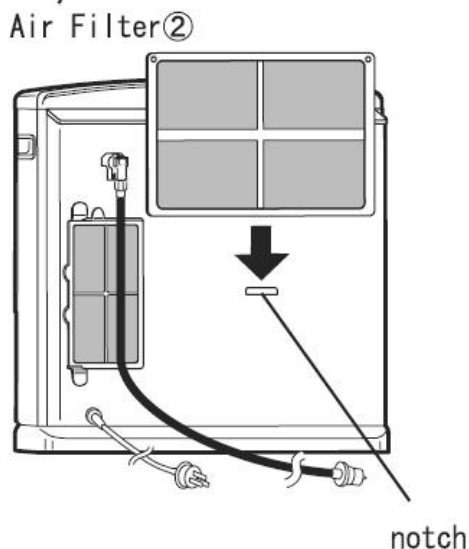

REFIT THE FILTER

1. Hold the upper side of the Air Filter (1) and place the filter onto the notch
2. Tighten the screw

Warning

The heater should not be operated without the filter. Please refit filter correctly.

Service

Rheem Australia has a service and spare parts network in all states. Our service network personnel are fully equipped to give the best service on your Paloma gas heater.

**If your heater requires a service call
please contact Rheem National Service on 131 031.**

Do not return heater to place of purchase.

State Service & Spare Parts:

	QLD	SYD/CANB	NEWC	VIC	SA	WA
Service Tel	07 3213 0100	02 9684 9280	02 4961 3515	03 9212 8900	08 8343 0000	08 9351 4238
Service Fax	07 3213 0154	02 9684 9188	02 4961 3117	03 9212 8955	08 8359 6002	08 9353 4101
Parts Tel	07 3213 0102	02 9684 9282	02 4961 3515	03 9212 8911	08 8343 0044	08 9258 3099
Parts Fax	07 3213 0154	02 9684 9188	02 4961 3117	03 9212 8984	08 8359 6003	08 9356 9914

Approval

**These Paloma models have been approved by the Australian Gas Association
under AGA Approval Number: 6540**

*In keeping with our policy of continuous progress and product improvement,
we reserve the right to make changes without notice.*

DISTRIBUTED IN AUSTRALIA BY:

RAYPAK AUSTRALIA PTY LTD
ABN 65 078 743 414
(A DIVISION OF RHEEM AUSTRALIA PTY LTD)
39 KOORNANG ROAD
VIC 3179

SALES TEL: 1300 729 725
SALES FAX: 03 9757 3350

Printed: July 2008

15-01875-00